

COMPLETE
STENCIL
CATALOG



ITEM# 228



ITEM# 229

WE ACCEPT: **VISA**



Thank you for your interest in our Poly Vinyl stencils. The following pages contain information and prices on over 300 standard ready to ship items. Materials used for all of our stencils are 100% virgin polymers with thicknesses of 1/8" and 1/16" gauge to withstand heavy use. Our stencils are all designed to meet D.O.T. specs nationwide. Layout and designs follow through to the smallest stencil, allowing you to create more visible and proportioned markings. All stencils are cut with ample overspray and are designed for a quality job. Our stencils are easy to transport, lighter than wood or metal and clean up easily. When paint dries, it easily peels from polymer.

We have designed patterns and legends to suit your every need in pavement marking. In addition, our stencils are designed for many other types of applications. Some of the many uses for our stencils are as follows:

- Industrial Floor Marking
- Wall Legends
- Machinery Labeling
- Factory Safety Awareness
- Athletic Fields
- Running Tracks
- Airports
- Logos

All of our stencils roll up easily for quick UPS shipping. Just order by item number or call us for a quote on any custom stencil you may need.

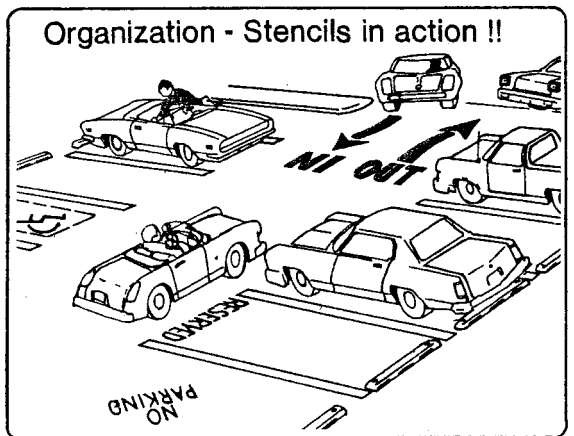
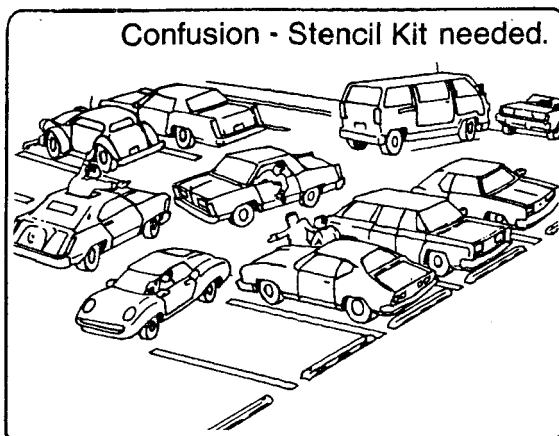

SAFETY FLOOR MARKING STENCILS

Poly-Vinyl Stencil SAFETY STENCILS

- LARGE 22" DIAMETER
- WORDS & GRAPHICS
- KEEP EMPLOYEES ALERT

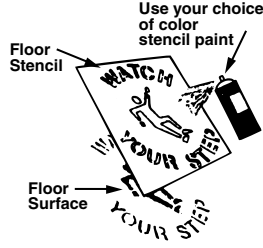

- Provide a permanent safety awareness message for employees
- Constructed of durable plastic for use over and over again

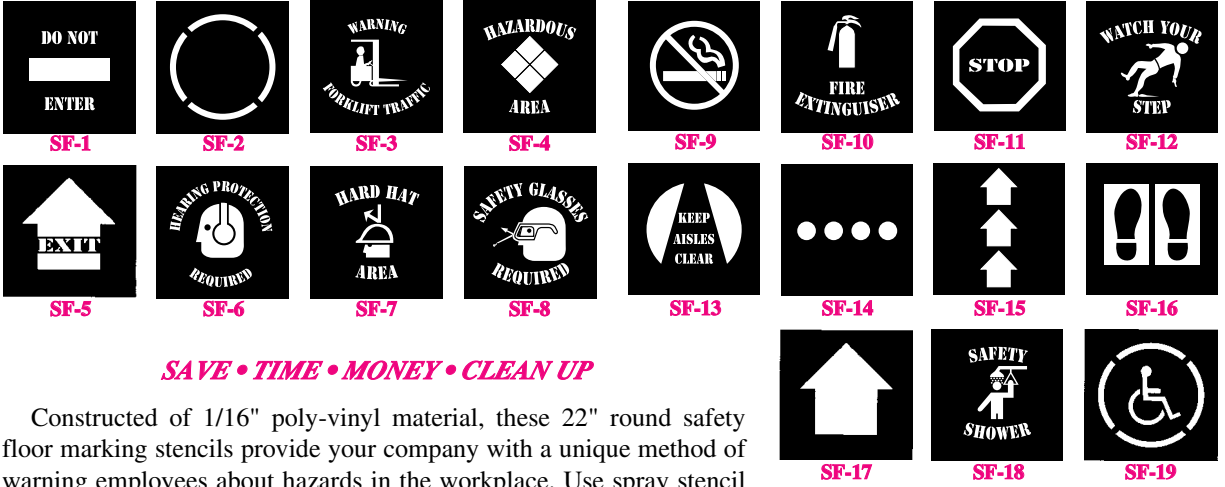

SAVE • TIME • MONEY • CLEAN UP

Constructed of 1/16" poly-vinyl material, these 22" round safety floor marking stencils provide your company with a unique method of warning employees about hazards in the workplace. Use spray stencil paint and permanently apply messages on floor, walls, or wherever you feel a warning is necessary. Just place the safety marking stencils on the area that you would like to apply the message—and paint!

ITEM #10

ENVIRONMENTAL

- Bay
- River
- Lake

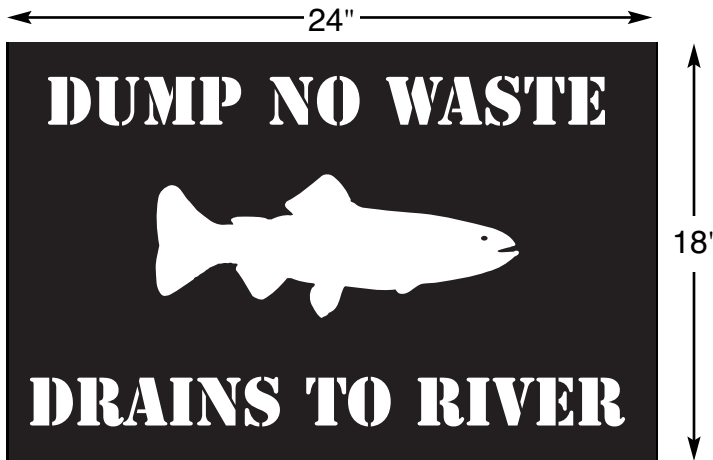

- Pond
- Ocean
- Stream

- Creek
- Wetlands

There's nothing little about our Giant® chalk boxes.

Giant Chalk Boxes (super size)

Why so big? It holds a lot of string and a lot of chalk. (Fully loaded the G150 weighs about two pounds). If you're snapping dozens of lines, or need big bold lines provided by the thicker string, grab a Giant and get the job done.



RoadRunner®

- It's easy to measure curved, horizontal and asymmetrical surfaces.
- Weighs **less than 2 pounds**.
- 5-digit, easy-read, **magnified counter** measures **9,999 feet**.
- RR112's handle telescopes from **17 inches** to fit into a toolbox or briefcase **up to 38 inches** to measure without bending.

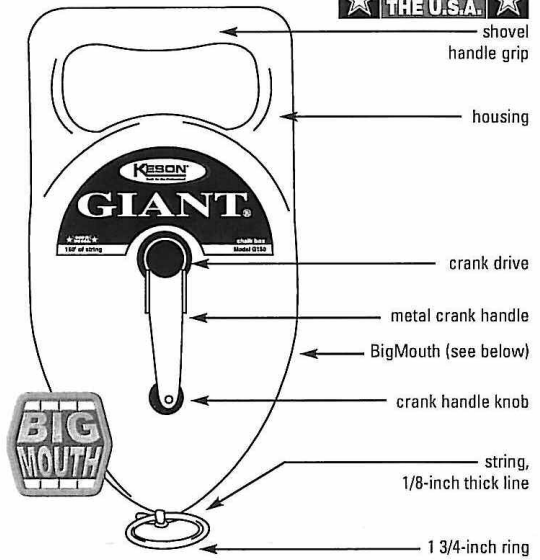

Ultra-Glass Fiberglass Blades

300 ft.

- Tough, molded handle is reinforced with metal to provide years of rugged use.
- The crank handle is reinforced with metal to provide years of rugged use.
- Double-throat rollers guide the blade return and prevent the tape from twisting.
- The shovel handle is ideal for rapid reeling.



We make your job easier.



Easy to Transport • Light weight
Will not warp out of shape



•Fast Easy Clean Up
•Paint Breaks & Falls Away by Flexing & Tapping a Hard Surface



New Products Every Month!
The Best Stencil for the Job

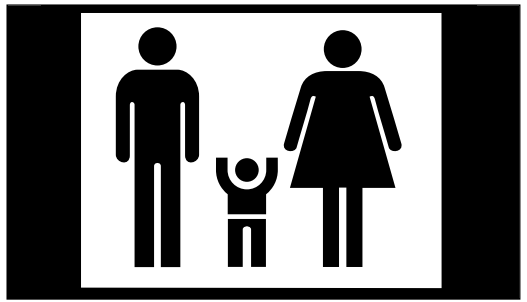

Unlike wood, aluminum, and other stencils,
they won't break, warp, bend, crease or load
up with paint.



Virtually Indestructible Poly Vinyl Stencils are
designed for the heaviest use, misuse, and abuse.
With minimum care, they will last a lifetime.

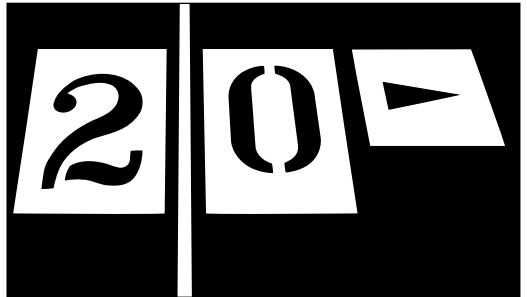

Variety of Products
Custom Orders

— **SAVE** —

- **TIME**
- **MONEY**
- **CLEAN UP**

Custom Stencils Manufactured to your Specifications.

If you don't see it – ask for it!

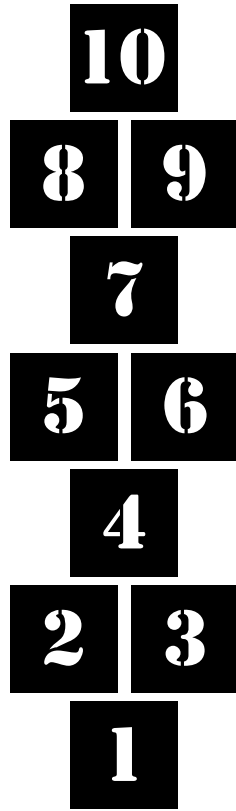
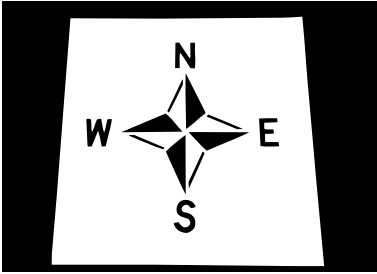

ITEM #125C

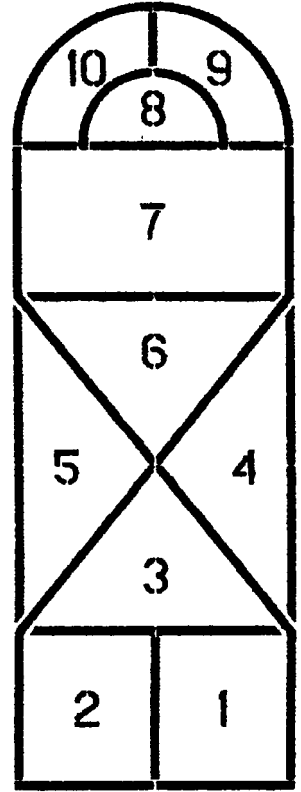

ITEM #125E

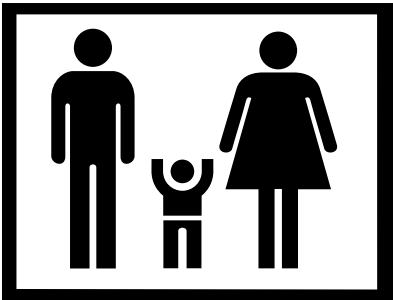

ITEM #216

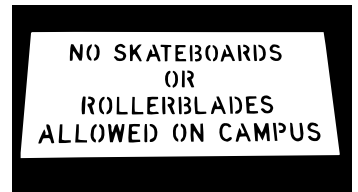
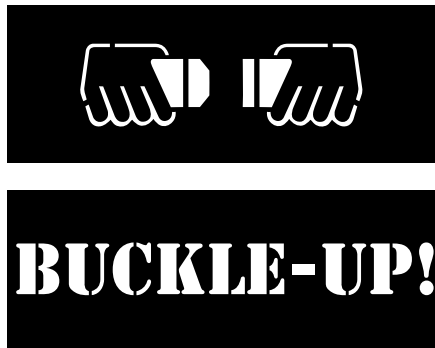



Water-base formula • Safe for grass

**Golf Courses • Construction
Athletic Fields • Landscape
Parks • Survey • Irrigation**



Colors Available:

- White #20-642
- Yellow #20-646
- Handicap Blue #20-649
- Black #20-783

Above cans fit #Z-604 machine

Seymour's STRIPE TRAFFIC MARKER is formulated to apply with the STRIPE MARKING MACHINE. It's the easy way to stripe parking lots, plants, warehouses, athletic fields and other sites where traffic control is required. Designed for use on all surfaces including concrete, blacktop, gravel, dirt and grass. Seymour Stripe Marking Paint is heavily pigmented for long lasting, one-coat coverage yielding a clean, crisp line up to 4" wide when applied with Seymour's Stripe Marking Machine. The non-clogging formula is formulated with water for greater safety, but the paint is *not* soluble in water and will not wash away. The unique spray head is designed for *exclusive* use with the Stripe Marking Machine.



- One-pass coverage
- Bright vivid stripes
- Contains water, lower flammability
- Non-clogging
- Long lasting—Not water soluble

STRIPE MARKING MACHINE-Z-604

The new Stripe Marking Machine is the most versatile applicator available. It comes ready to use and there are no accessories to buy. Just set the simple adjustment for stripe widths from 2" to 4" and apply sharp, even lines every time.

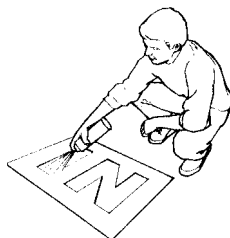

Easy to Use One-Piece Stencils

9" HIGH LETTERS



ITEM #188A

9" HIGH LETTERS

**NO
PARKING**

ITEM #188B

4" HIGH LETTERS

**WAIT FOR
WALK SIGNAL**

ITEM #167B

6" HIGH LETTERS



ITEM #146B

Wheel Stop Stencils

10" HIGH LETTERS



ITEM #142B

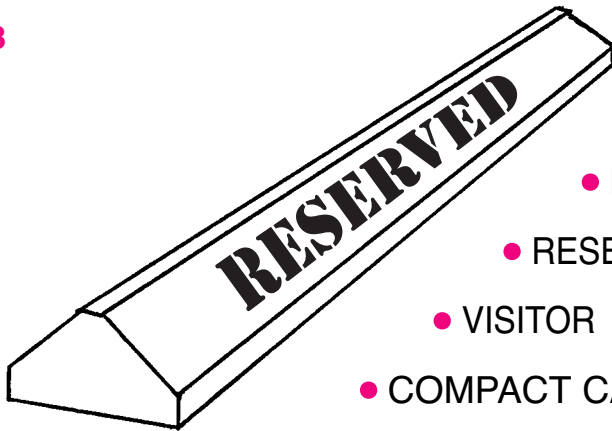

• 2³/₄" HIGH LETTERS

• HANDICAPPED

• RESERVED

ITEM #239

• VISITOR

• COMPACT CARS

*1/16" Poly

Fuel Identification/Environmental Stencils

ONE PIECE ALL 3" HIGH LETTERS

*1/16" Poly

VAPOR
RECOVERY



REGULAR



KEROSENE



DIESEL

PREMIUM



PLUS

ITEM #240

Parks and Recreation Stencils

3" HIGH LETTERS

*1/16" Poly

RESERVED



VISITOR



NO PARKING



FIRE LANE

ONLY



HANDICAPPED

ITEM #241

Easy to Use One-Piece Stencils

MAKE DANGEROUS AREAS MORE VISIBLE

ITEM #244 ENTER STENCILS
24"W x 6"H 2½" LETTERS



ITEM #244 EXIT STENCILS
24"W x 6"H 3½" LETTERS



ITEM #244 FIRST AID STENCILS
24"W x 6"H

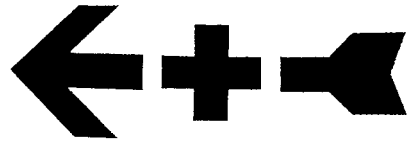

COMMERCIAL SAFETY MARKINGS FOR:
DOORS, WALLS, BATHROOMS, SHOWERS,
INDUSTRIAL SITES, CONSTRUCTION PROJECTS,
SCHOOLS, CAMPS, RV PARKS & STADIUMS.

SHEET MATERIAL

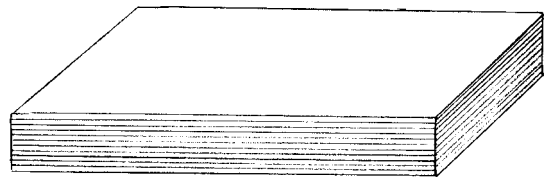

1/8" x 108" x 50"

1/8" x 156" x 50"

1/16" x 108" x 50"

AVAILABLE
SIZE

VISIBILITY MEANS SAFETY!

**FOR THOSE ONE TIME JOBS OR
SPECIALS DO IT YOURSELF!**

Easy to Use One-Piece Stencils

CLEAN UP! TRASH YOUR TRASH



ITEM #245
10"W x 12"H

NO ROLLER SKATING



ITEM #246
26" DIAMETER

BIKE SHARED LANE

2-PIECE STENCIL



ITEM #247
40"W x 111"H

BIKING AWARENESS



ITEM #248
20"W x 18"H

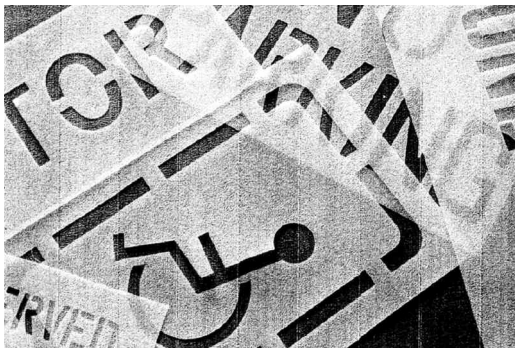

Stick to Your Budget and Get Every Stencil You Need

STOCK ECONOMY PLASTIC STENCIL KIT

Kit includes the following plastic stencils:

- 9" letters (A-Z), 9" numbers (0-9)
- Words in 9" letters: SLOW SPEED, NO PARKING
- Words in 10" letters: ONE WAY
- Words in 19" letters: IN, OUT
- 22" x 15" arrowhead; 20" arrow stems
- 31" x 19" Disabled Access Symbol

ITEM #243

* $\frac{1}{16}$ " Poly

*1/16" Material

Item No.	Description
10	Floor Marking Stencils SF-1 thru SF-19 (1/16" Poly)
96	2" letters & numbers (1/16" Poly)
97	3" letters & numbers (1/16" Poly)
98	4" letter
99	4" numbers
100	6" letters
101	6" numbers
101A	8" letters
101B	8" numbers
102	10" numbers
102A	10" letters
103	12" numbers
104	12" letters
104A	18" letters
104B	18" numbers
105	24" numbers
106	24" letters
107	36" letters
107A	36" numbers
108	48" numbers
108A	48" letters
108B*	48" x 10" wide letters "B,I,K,E,L,A,N,E,O,N,L,Y,X,-,I,N,G" any single letter or combination of
109	72" letters
109A	72" numbers
110	96" letters (6" stroke)
110A	96" letters (4" stroke)
110B	96" numbers (6" stroke)
110C	96" numbers (4" Stroke)
111	Handicap symbol (24 x 36 x 2" stroke)
111A	Handicap symbol (33 x 42 x 2 3/4" stroke)
111B	Handicap border (for 111 & 111A)
111C	Handicap symbol (36 x 42 x 3 1/2" stroke)
112	Handicap symbol (18 x 12)
112A	Handicap symbol w/border (20 x 32)
112B	22" combination 3 pc. Arrow Kit Arrow A Straight & Curve 36" Arrow B Straight & Curve 36" Arrow C Straight & Curve 48"
113	6' straight arrow (2 pc.)
114	6' curved arrow (2 pc.)
115	6' arrow w/curved & straight tails (3 pcs)
115A	5' straight arrow (1 pc.)
115B	5' curved arrow (1 pc.)
115C	3 piece Arrow Kit
116	5' "R" for railroad xing (2' x 5' x6" stroke)
116A	6' Federal "R" for Railroad (1' x 6' x 3" stroke)
116B	6'6" "R" for Railroad • Penn DOT special
117	6' "R" for Railroad xing (2' x 6' x 6" stroke)
117A	"X" for Railroad xing
117B	"X" for Railroad xing • Penn DOT special
118	Federal curve arrow
118A	Federal combo tail
119	Federal straight arrow
119A	Penn DOT curved arrow
119B	Penn DOT straight arrow
119C	3 pc. Large Arrow Kit
119D	Straight Arrow
119E	Curve Arrow
119F	Straight Arrow

Item No.	Description
119G	Curve & Straight Arrow Combination
119H	Straight Outline Arrow
119I	Curved Outline Arrows
119J	3 Pc. Large Arrow Kit
119K	Set Straight & Curved Arrows
119L	Fed. U-Turn Arrow
119M	Fed. Lane Reduction Arrow
120	8' x 16" Stop Bar
120A	8' x 24" Stop Bar
121	8' x 12" Stop Bar
122	8' x 6" Stop Bar
123	8' x 4" Stop Bar
123A	Barricade Stripe (6" x 72")
123B	Bicycle Loop (17" x 43")
124	Fire Hydrant Symbol w/Arrow (18" x 33")
124A	Child Running (25" x 48")
124B	Bike Lane Symbol (17" x 33")
125	Maltese Cross Symbol (37" x 37")
125A	Pedestrian Crossing Symbol (36" x 60")
125B	Bike Lane Symbol (24" x 48")
126	Bike Lane Symbol (40" x 60")
125D*	Bike Lane Symbol w/Arrow
125C	Hopscotch Board w/Numbers (96" x 24")
125E	Hopscotch Board w/Numbers
126A*	Bike Trail Symbol (65" x 40")
126B*	"No Bicycle" Symbol (42" Diameter)
126C	Bicycle Diamond (36" x 72")
126D	10" SENIOR
127	10" MANAGER
127A	10" HANDICAP
128	10" LOADING
128A	10" CUSTOMER
129	10" STAND
130	10" ASST
131	10" CHIEF
131A	10" STOP
132	10" FIRE
133	10" LANE
134	10" ZONE
135	10" TAXI
136	10" MGR
137	10" DOCTOR
138	10" PRESIDENT
139	10" RESERVED (condensed)
139A	10" RESERVED
139B	10" PARKING
140	10" VICE
140A	10" ONLY
141	10" VISITOR
141A	10" COMPACT
141B	10" CARS
141C	6" PARKING
142	6" NO PARKING
142A	6" COMPACT
142B	10" 1 pc. ONE WAY
143	10" NO PARKING
144	6" HANDICAP
145	Multi-Purpose Arrow (Straight 22")
146	Multi-Purpose Arrow (Curved 24")
146B	6" 1 pc. STOP-LOOK



123A



123B



124



124A



125



125A



125B/126



125D



126A



126B



126C



152, 152A



148A



148A

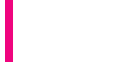

149



150



150A



150B

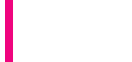

150C



151



151A



151B



152



152A

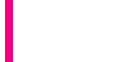

152B



152C

153

154

155

156

157

157A

157B

157C

157D

157E

158

158A

159

159A

159B

160

161

162

162A

162B

162C

162D

163

163A

163B

163C

164

165

166

167

167A

167B

168

168A

168B

168C

169

170

170A

171

171A

172

173

ONLY
SCHOOL
XING
STOP



117A



117B



117B

QUALITY PRODUCTS AND FAST SERVICE!

All our stencils will always lay flat, yet will flex to conform to any surface—smooth or rough. Apply paint with brush, roller or spray equipment. Flexible stencils will not develop a paint build up. When paint dries, it simply flakes off.

Designed for heavy use, with minimum care our stencils will last a lifetime. Unlike wood, aluminum or other stencils, our stencils will not break, bend, crease, warp or load up with paint.

All stencils are cut to give crisp, accurate markings.

Yield Line

**ITEM
#215C**

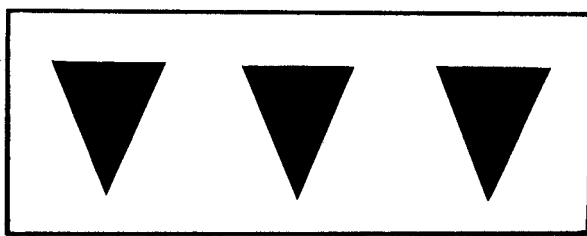

SPECIFY SIZE

AVAILABLE SIZES

12"x18"

16"x24"

24"x36"

(3 images on 1 stencil)

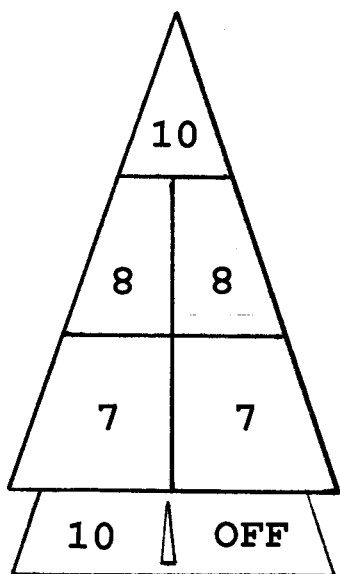

Shuffle Board

6'x10'x6"

ITEM #152C



21 Pc. Kit

ITEM #242

KIT INCLUDES:

8" VISITOR RESERVED
0 - 9

9" NO PARKING
SLOW SPEED
ONE WAY

18" STOP
IN
OUT

HANDICAP SYMBOL
w/BORDER

3 PC. ARROW KIT

*1/16" Poly

Item No.	Description	Item No.	Description
174	8" CHIEF	214B	ROLLER BLADING In-Line Skating Symbol
175	8" FIRE	215	Pool Kit - includes seven (7) one-piece legends, 4" number set, and four (4) 9" symbols
176	8" LANE	215A	Stork Symbol *1/16" Poly
177	8" ZONE	215B	Baby Carriage Symbol *1/16" Poly
178	8" TAXI	215C	Yield Lines (specify size)
179	8" MGR	216	"Buckle Up!" - includes symbol & legend
180	8" DOCTOR	217	48" NO (1piece)
181	8" PRESIDENT	217A	48" LANE
182	8" RESERVED	217B	48" AHEAD
183	8" VICE	218	48" SLOW (1piece)
184	8" VISITOR	219	48" YIELD (1piece)
185	8" COMPACT	220	48" STOP (1piece)
186	8" CARS	221	48" EXIT (1piece)
187	8" NO PARKING	222	48" DRIVE (1piece)
187A	8" PARKING	223	48" DO (1piece)
188	8" HANDICAP	224	48" THRU (1piece)
188A	9" 1 pc. SLOW SPEED	225	48" NOT (1piece)
188B	9" 1 pc. NO PARKING	226	48" ONLY (1piece)
189	18" NO	227A	48" ENTER (1piece)
190	18" PARKING	227B	ADA Symbol w/No Parking
191	18" FIRE	228	ADA Symbol w/Van Accessible
192	18" ZONE	229	ADA Symbol w/Hdcap Parking
193	18" LANE	230	Crosswalk Bars (24" x 72")
194	18" ONLY	231	Line Stencil (4" x 144")
195	18" ONE	232	California Loops (specify size)
196	18" WAY	233	Wheel Stop Overspray Kit
196A	18" DO	234	Recycle Symbol: 12" 24" 16" 18" 36" 48"
196B	18" NOT	235	Recycle Kit (5piece 2" letters)
197	18" DRIVE	236	Recycle Kit (5piece 4" letters)
198	18" THRU	237	Recycle Kit (5piece 6" letters)
198A	18" EXIT	238	Giant Economy Starter Kit (1/16" Poly) 1 set 8" (0-9), 1 set 8" (A-Z) 1 ea 9" (slow speed / no parking) 1 ea Reserved ADA Symbol 1 ea 10" One Way, 1 set 18" In / Out 1 ea Arrowheads, Curve & Straight Tails
198B	18" ENTER	239	Wheel Stop Stencils 2 3/4" letters (specify legend)
198C	18" STOP	239A	No Parking Symbol
198D	18" IN	239B	No Skateboard Symbol
198E	18" OUT	240	Fuel Identification Stencils (specify legend)
199	24" NO	241	Parks and Recreation Stencils (specify legend)
200	24" PARKING	242	Stencil Kit 21 pc. (as per list)
200A	24" DO	243	Economy Kit *1/16" Poly
200B	24" NOT	244	Emergency Exit & Enter w/Arrows (specify legend)
201	24" FIRE	245	Trash Can Symbol
202	24" LANE	246	No Roller Blading Symbol
203	24" ZONE	247	Shared Bike Lane Symbol
204	24" ENTER	248	Biking Awareness Symbol
205	24" EXIT		
206	24" DRIVE		
207	24" THRU		
208	24" LOADING		
209	24" ONE		
210	24" WAY		
210A	24" STOP		
210B	24" ONLY		
211	6" LOADING		
212	6" ZONE		
213	6" LANE		
214	6" FIRE		
214A	6" GOLF CART		

Easy to Use One-Piece Stencils

BABY & CARRIAGE

32"W x 36"H



ITEM #215B

BABY & STORK

45"W x 24"H



ITEM #215A

GOLF CART

36"W x 28"H



ITEM #214A

ROLLER BLADING IN-LINE SKATING

16"W x 20"H



ITEM #214B

NO PARKING SYMBOL

26" DIAMETER



ITEM #239A

NO SKATEBOARDS

26" DIAMETER

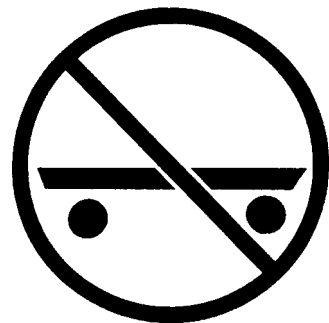

ITEM #239B

STRIPE MARKING PRODUCTS

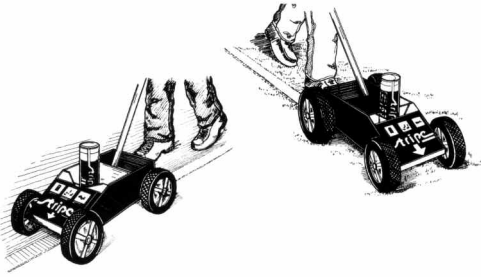

TRAFFIC MARKING PRODUCTS

For asphalt and concrete applications

- **Schools:**
 - Elementary
 - High/Middle
 - Colleges
 - Parking Lots
 - Playgrounds
- **Apartment Complexes**
- **Churches**
- **Rental Yards**
- **Golf Courses**
- **Paving Contractors**
- **Water/Sewer Lines**
- **Hotels**
- **Public Works Municipal Projects**

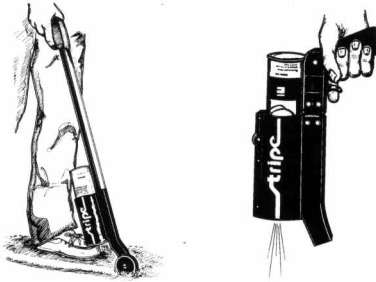

ATHLETIC MARKING PRODUCTS

For grass and turf applications

- **Schools:**
 - Elementary
 - High/Middle
 - Colleges
 - Soccer Fields
 - Football Fields
 - Baseball/Softball Fields
 - Track Fields
 - Field Hockey Layouts
- **Rental Yards**
- **Golf Courses**
- **Nurseries**
- **Paving Contractors**
- **Landscaping**
- **Home Landscaping Layouts**

Professional Results

with Minimal Investment

Ideal for:

- Rush Jobs
- Small Jobs
- Stenciling

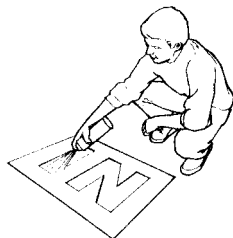

FEDERAL LANE REDUCTION ARROW

18' LONG x 5'6" WIDE

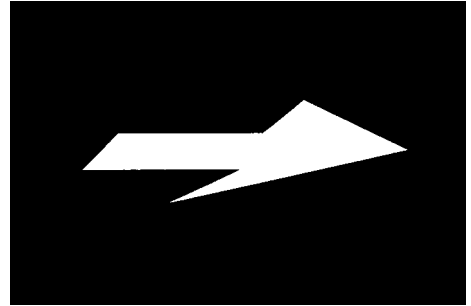

ITEM #119M

FEDERAL U-TURN ARROW

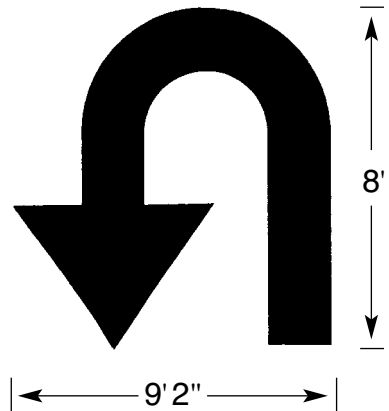

ITEM #119L

3 PIECE ARROW KIT

37" Straight Arrow 43" Curve Arrow

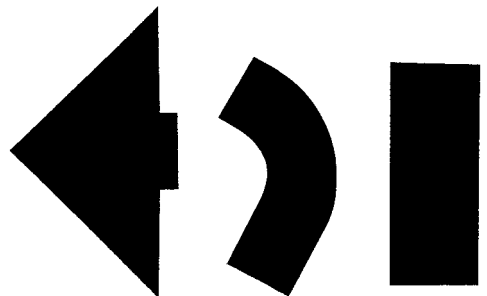

ITEM #115C

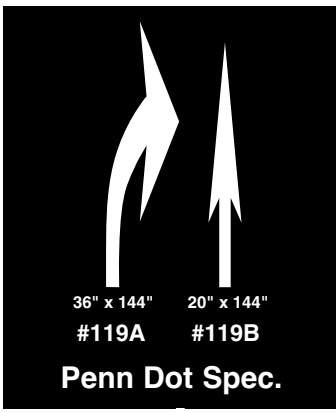

ITEMS #119A & 119B



ITEM #215

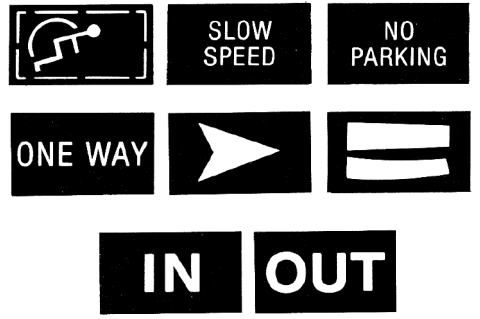

1 set 8" 0 to 9 & 1 set 8" A to Z
ITEM #238 ^{1/16"} Poly

Outline Arrows

LEAVES A 4" WIDE OUTLINED ARROW

ITEM #119H

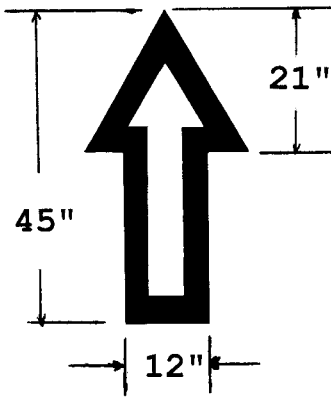

ITEM #119I

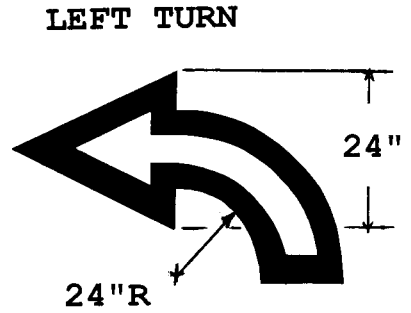
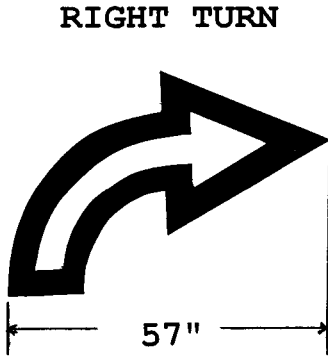

3 Pc. Arrow Kit

36" WIDE x 90" HIGH

ITEM #119J

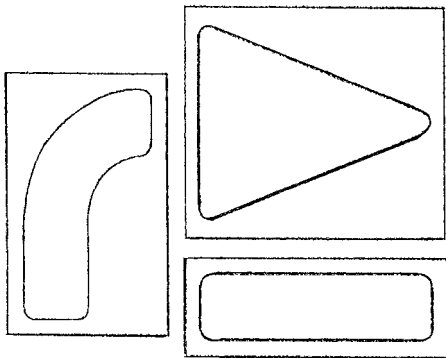

2 Pc. Arrow Kit

20" WIDE x 42" HIGH

ITEM #119K

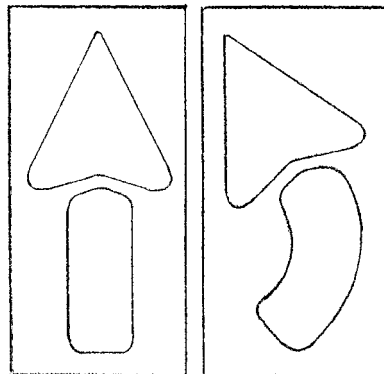

ITEM #119C
Three Piece Universal Arrow Set

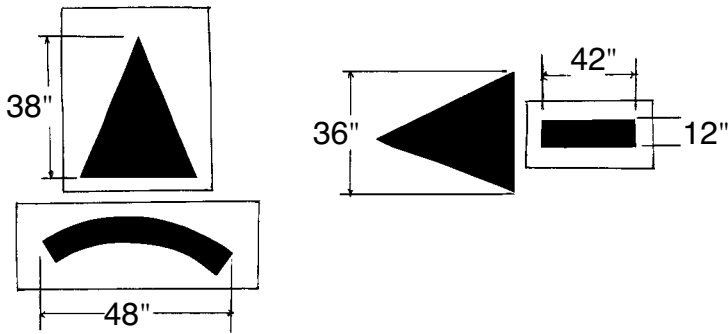

ITEM #119F
6' 1 pc. arrow

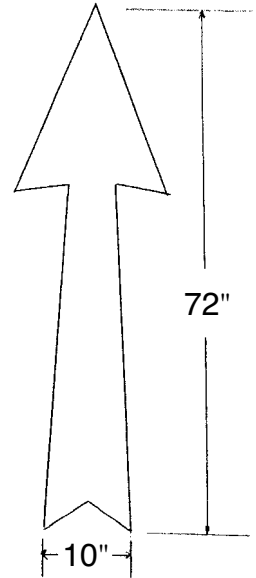

ITEM #119D

ITEM #119E

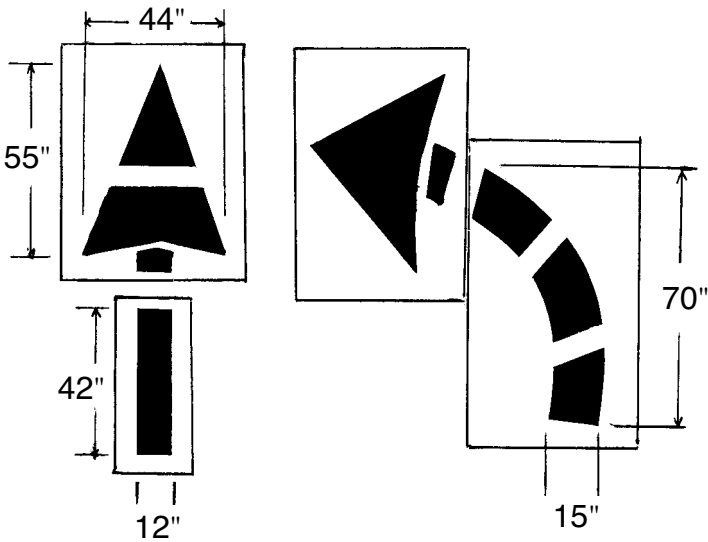

ITEM #119G
6' 1 pc. arrow
combination

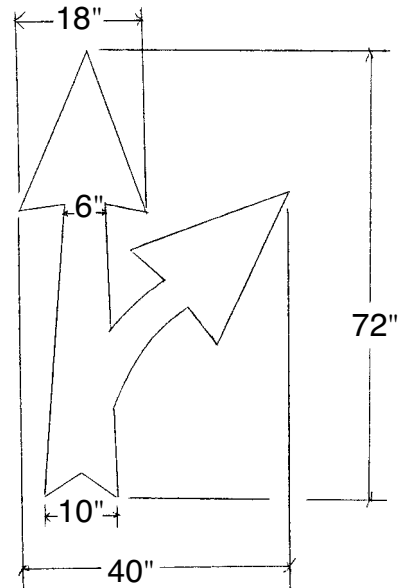

ARROW #112B
Three Piece Set

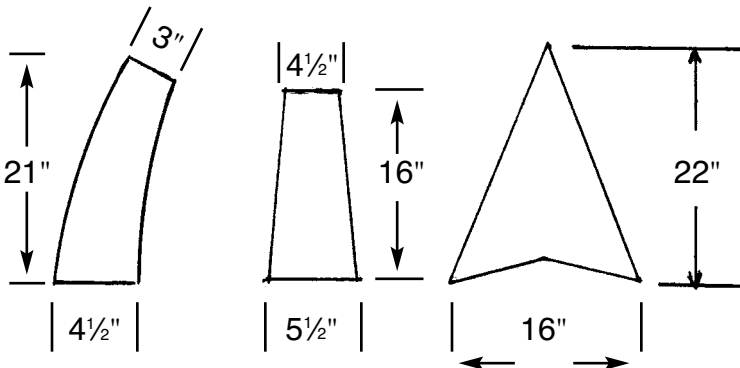

FEDERAL SPEC. ARROWS

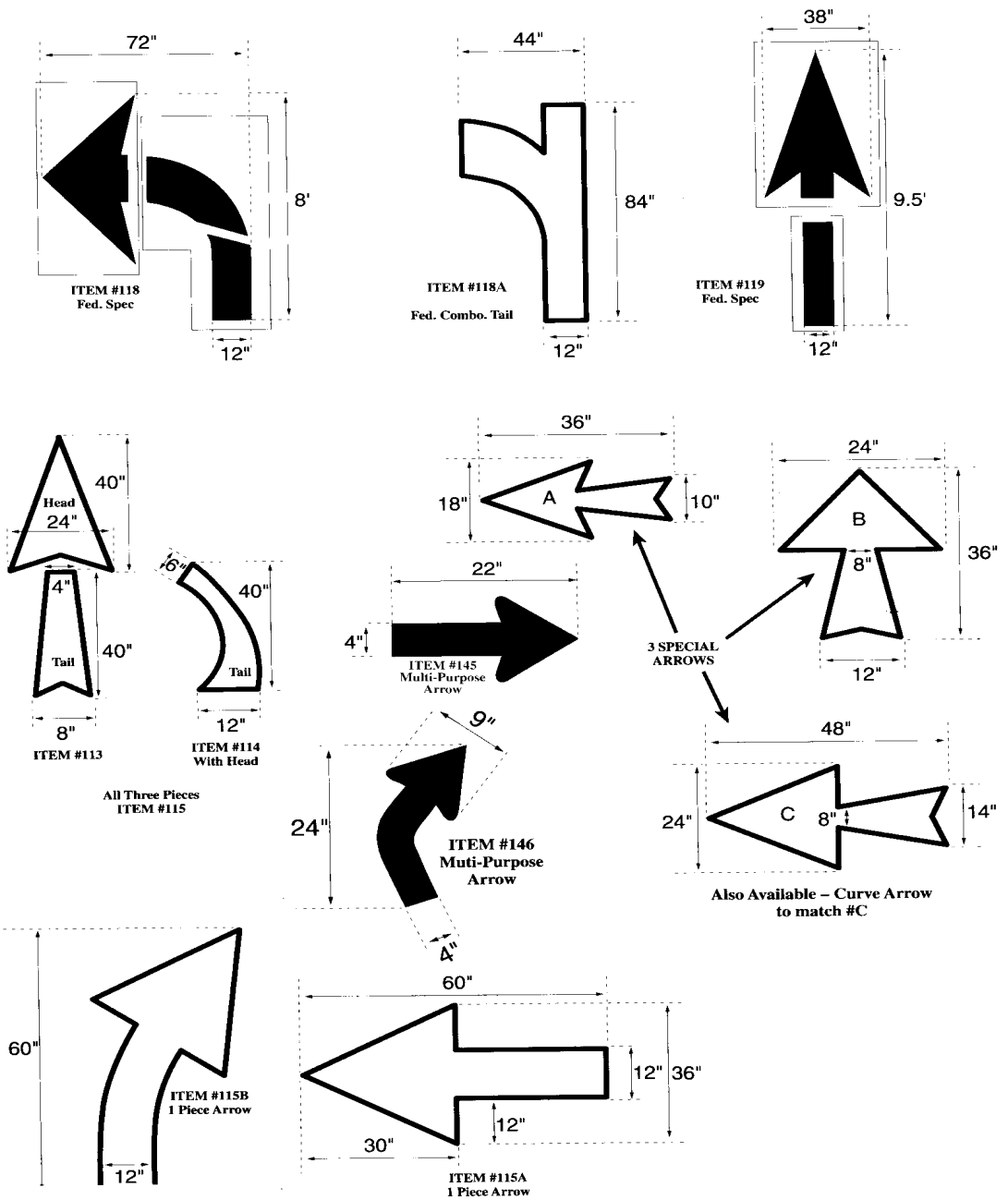

24"x72" & 36"x72"



Crosswalk Bar
ITEM #230

4"x144"

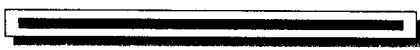

Line Stencil
ITEM #231



California Loop
ITEM #232



Wheel Stop Overspray
ITEM #233



ALUMINUM
CANS ONLY

PAPER ONLY

PLASTIC ONLY

GLASS ONLY

WASTE ONLY

ITEMS #234/235/236/237

NEW PRODUCTS



ITEM# 222 2 PIECE

**48" HIGH
LETTERS**



ITEM# 223



ITEM# 224

**1 PIECE
& 2 PIECE
STENCILS**

**Made on
Durable
1/8" Poly
Material**

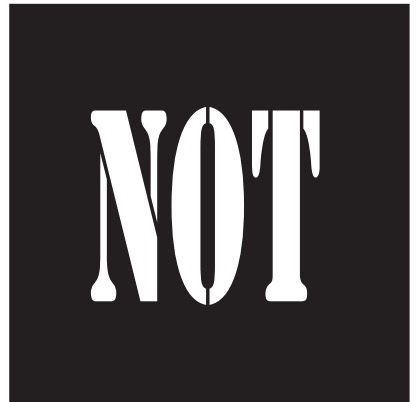

ITEM# 225



ITEM# 226

**Legends
48" High
Letters**



ITEM #227A 2 PIECE



ITEM #217A



ITEM #217B 2 PIECE



ITEM# 217



ITEM# 218

**48" HIGH
LETTERS**

**Made on
Durable
1/8" Poly
Material**



ITEM# 219 2 PIECE



ITEM# 220



ITEM# 221

NEW ADA SYMBOLS

1 PIECE STENCIL



ITEM # 227B

**12"X18" SYMBOL
W/6" WORDING
MADE ON 1/8" POLY**



ITEM# 228



ITEM# 229

BRASS INTERLOCKING STENCIL KITS

GOTHIC style

Horizontal Composition

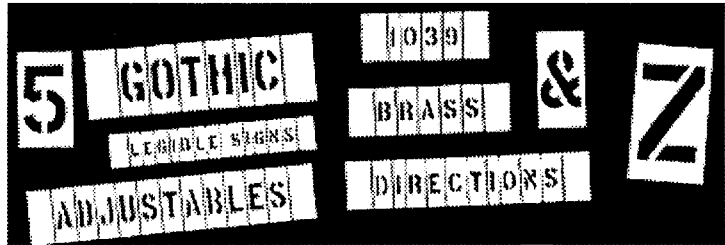

- Durable brass for long-lasting service.
- Clean with paint solvent.
- Quick, legible signs on all surfaces.
- Slide together and come apart easily.
- Use brush or spray ink, paint or use markers.

Numbers Only, Single Sets 15 Pieces As follows: 1234567890 1-Beginner, 1-Plain Ender 1-Dash, 1-Period			
Number	Size Description		
10006	1/2"		
10007	3/4"		
10008	1"		
10009	1-1/2"		
10011	2"		
10012	2-1/2"		
10013	3"		
10014	4"		
10015	5"		
10016	6"		
Model Number	Product Description	Weight (lbs.)	UPC 081834
10006	1/2" Numbers	0.10	10006-7
10007	3/4" Numbers	0.12	10007-4
10008	1" Numbers	0.14	10008-1
10009	1-1/2" Numbers	0.18	10009-8
10011	2" Numbers	0.28	10011-1
10012	2-1/2" Numbers	0.34	10012-8
10013	3" Numbers	0.42	10013-5
10014	4" Numbers	0.58	10014-2

Letters Only, Single Sets 33 Pieces As follows: ABCDEFGHIJKLMNOQRSTUVWXYZ& 1-Beginner, 1-Period Ender 1-Spacer, 1-Comma, 1-Dash, 1-Period			
Number	Size Description		
10026	1/2"		
10027	3/4"		
10028	1"		
10029	1-1/2"		
10031	2"		
10032	2-1/2"		
10033	3"		
10034	4"		
10035	5"		
10036	6"		
Model Number	Product Description	Weight (lbs.)	UPC 081834
10026	1/2" Letters	0.18	10026-5
10027	3/4" Letters	0.20	10027-2
10028	1" Letters	0.24	10028-9
10029	1-1/2" Letters	0.34	10029-6
10031	2" Letters	0.52	10031-9
10032	2-1/2" Letters	0.68	10032-6
10033	3" Letters	0.84	10033-3
10034	4" Letters	1.18	10034-0

**Other
Kit
Sizes
Available**

CALL FOR PRICING